

Cover Page:

GroWell BT Hair Growth System – *User Manual*

Instructions for Use (IFU): Part# GW10014

Apira Science, Inc.

409 Edmon Rd NE, Suite C

Albuquerque, NM 87107

USA

+1 949 854 9900



GroWell BT IFU Revision 10

Table of Contents:

Table of Contents:

GroWell

- Purpose (Indications for Use)
- Product Description
- Contraindications
- Risks and Benefits
- Expectations and Procedure
- Warnings and Precautions

Instructions for Use

- Frequency and Duration of Use
- Set Up Instructions
- Operating Instructions
- Monitoring Device Activity
- Cleaning Instructions
- Maintenance Instructions
- Operating and Storage Transportation Instructions
- Expected Life of the GroWell
- Disposal Instructions
- Troubleshooting

Warranty

Safety Labels

Symbol Explanation

Technical Specifications

EMC Statement

FCC Statement

User Assistance

Appendix A: EMC Information



Please read the entire owner's manual before using the GroWell.

Purpose (Indications for Use):

MEN - The GroWell BT Hair Growth System ("GroWell") is designed to promote hair growth in males with androgenetic alopecia who have Norwood Hamilton Classifications of IIa to V.

WOMEN - The GroWell is designed to promote hair growth in females with androgenetic alopecia who have Ludwig-Savin classifications of I-II.

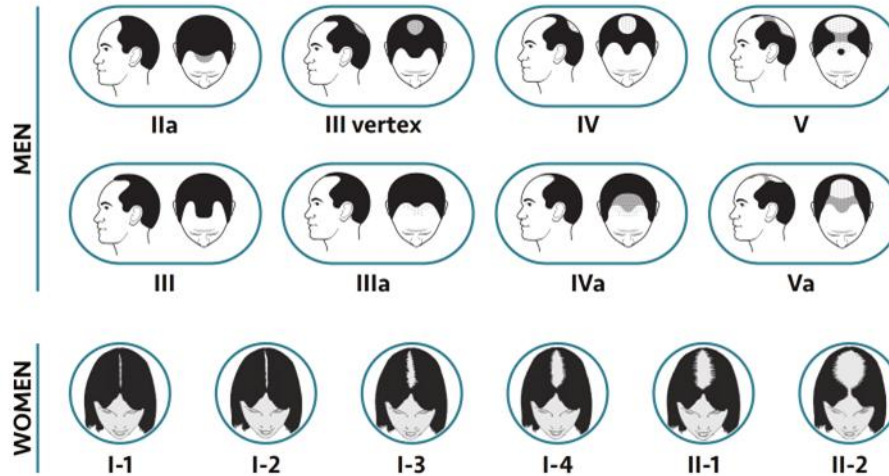

The GroWell is approved for Fitzpatrick skin types I-IV:



Use of the GroWell according to the guidelines and instructions provided will result in maximum effectiveness. If the use of the GroWell is discontinued, improvements may gradually decrease.

Product Description:

The GroWell consists of 24 proprietary red light diode lasers and 39 proprietary red light super-luminescent diodes configured in a flexible panel which is inserted in an adult sized, baseball-style cap. The GroWell's combination and configuration of diode lasers and non-laser LEDs provides for a full coverage of the upper 1/3 of the head; i.e, the scalp area roughly from the top of the head to the top of the ears.

For safety and convenience, the GroWell session will be "paused" and the light array will automatically turn off if the user removes the GroWell during use, and will resume when it is replaced on the head.

At the end of the 25-minute session, the lights will turn off and the GroWell will emit two audible beeps to signal that the therapy is complete.

Contraindications:

- **GroWell should not be used by children under 18 years of age.**
- **Do not use GroWell if you have cancer on your scalp.**
- **Do not use GroWell if you are taking medications which make you sensitive to the sun or light.**
- **If you are undergoing treatment for a dermatological or other medical**

condition, consult your physician before using GroWell.

- **Do not use GroWell if you have experienced previous sensitivity to 655nm red light.**

Risks and Benefits:

Low Level Light Therapy (LLLT) as used in the GroWell has been designated NSR (Non-Significant Risk) by most of the worldwide regulatory bodies. See the Warnings and Precautions section of this manual for additional risks.

Used as instructed, GroWell is indicated to promote hair growth in both men and women. If use of the device is discontinued results may gradually decrease.

Expectations and Procedure:

GroWell is recommended for men and women with mild to moderate hair loss. To set up and use, follow the instructions below.

During treatment, the light panel may warm slightly but you should feel no extreme heat or discomfort. You can clip the battery pack to your belt or pocket and watch television, read, browse the web or engage in any light activity. You will hear two short tones to alert you when the 25-minute session is complete. Remove the GroWell from your head and store in a safe, dry place until its next use.



Note: For safety and convenience, the GroWell has been programmed with a sensor to indicate that it's in place during treatment. If you remove the GroWell during a session, the lights will turn off and the session will be "paused" automatically. To resume, simply replace the GroWell on your head and the session will pick up where it stopped and continue to its completion.

If the sensor in your GroWell is not working properly, discontinue use and contact Apira Science, Inc. Customer Service at **1-949-854-9900** or support@apirascience.com for assistance.

Healthy hair grows about one half inch per month, and regrowth may not begin for several weeks so patience is needed. For best results, use GroWell every other day for 16 weeks. If you miss a session don't be concerned- just continue your next scheduled use. Typical users will start to see increased hair coverage and density within 4-6 months of use. Once the 16 weeks is completed, use as frequently as needed to continue the GroWell's benefits and maintain results.

Warnings and Precautions:



Warnings:

TO REDUCE THE RISK OF ELECTRICAL SHOCK THAT MAY CAUSE INJURY OR DEATH:

- The patient is an intended operator.
- Do not operate the GroWell in close proximity to anything marked with this logo:  which stands for electromagnetic frequency (i.e. cellular tower).
- Do not put tension on the cord when untangling or straightening, which may break the cord or connections causing a malfunction or electrical hazard. Do not subject the device to heavy shocks, which may damage the light diodes or other components.
- **WARNING:** Water and electricity are a dangerous combination! Avoid getting the GroWell wet, which may result in electric shock.
- Never use the GroWell when your hair is wet.
- Do not use, place or store the GroWell or its components where they can become wet, fall or be pulled into a bath, sink, swimming pool or other body of water. Do not let water run into the GroWell or its components.



- Do not use this device if you have any conditions which makes you sensitive to light.
- Use only the power adapter and cables provided with the GroWell
- Do not operate the GroWell if it has a damaged cord, adapter or connection. See the User Assistance section below for instructions on contacting Customer Support.
- Do not conduct any servicing or maintenance while the GroWell is in use.
- Do not position the GroWell to make it difficult to operate the disconnection device.
- Keep the cord away from heated surfaces, which can cause the product to malfunction or produce an electrical shock.



- Keep the device away from lint, dust and sunlight, which may affect performance.
- Only use the GroWell according to the instructions provided. Any other use is not recommended.
- Do not point the lasers at the face, stare directly at the laser light or its reflection off a mirror-like surface.



- **WARNING:** This equipment is not intended for use by children. To avoid risk of injury, choking or strangulation or damage to the GroWell and its components, please keep the GroWell, including the cables, away from unsupervised children and pets.



- **WARNING:** Do not leave the device unattended when it is switched on to avoid the risk of fire or burns.

WARNING: The device is not intended for use by persons with reduced physical, sensory or mental capabilities or lack of experience and knowledge, unless they have been given supervision or instruction concerning use of the device to avoid the risk of fire or burns.

CAUTION: Always unplug the device after use to avoid risk of damage to the device.

Instructions for Use:

The GroWell is intended to treat mild to moderate thinning hair on the scalp of men and women. Use for any other purpose or on other parts of the body is not recommended.

- Do not fold, roll, mark or otherwise damage the light panel or its surface.
- **Warning:** The GroWell and its components have been tested for safety and effectiveness within their design and intended use. Modifications or use of this product outside its intended purpose as specified in this manual are not recommended.



User Contact: This symbol indicates that GroWell is a TYPE-BF applied part classification. There is No Harmful contact to the user in any fault or non-fault condition. All components are considered a TYPE BF Applied part (GroWell light panel, battery pack, AC adapter, USB cables and User Manual).

Frequency and Duration of Use:

Growell requires consistent, ongoing use to achieve results and maintain benefits. The treatment protocol for GroWell is one 25-minute session every other day with one day between sessions. GroWell sessions are pre-programmed and automatically controlled by the system. There is no evidence that exceeding the recommended duration or frequency of use will speed results or increase the effectiveness of the GroWell treatments.

Set Up Instructions:

Open GroWell Package



- Remove any bubble wrap or other protective wrapping.
- Gently slide off the product sleeve and open the white inner box.
- Lift the top portion of the inner carton.

Assemble Components

Unpack the components of the **GroWell** and make sure all the parts are present.



- (1) Power Adapter (100v-240v VAC, 50-60HZ)
- (2) Charging Cable (USB-A to USB-C)
- (3) Battery (1800 mAh)
- (4) GroWell Control Cable (USB-C to USB-C)
- (5) GroWell Light Panel Insert
- (6) GroWell Cap
- (7) QuickStart Guide

Operating Instructions:

Step 1- Charge the battery

- Undo the wire fastener on the Charging Cable (#2 in the diagram above), and use it to connect the battery (#3) to the Power Supply (#1).
- Plug the Power Supply into an electrical outlet
- Charge until the red light on the battery turns constant green (zero to fully charged in approximately 2-2.5 hours).

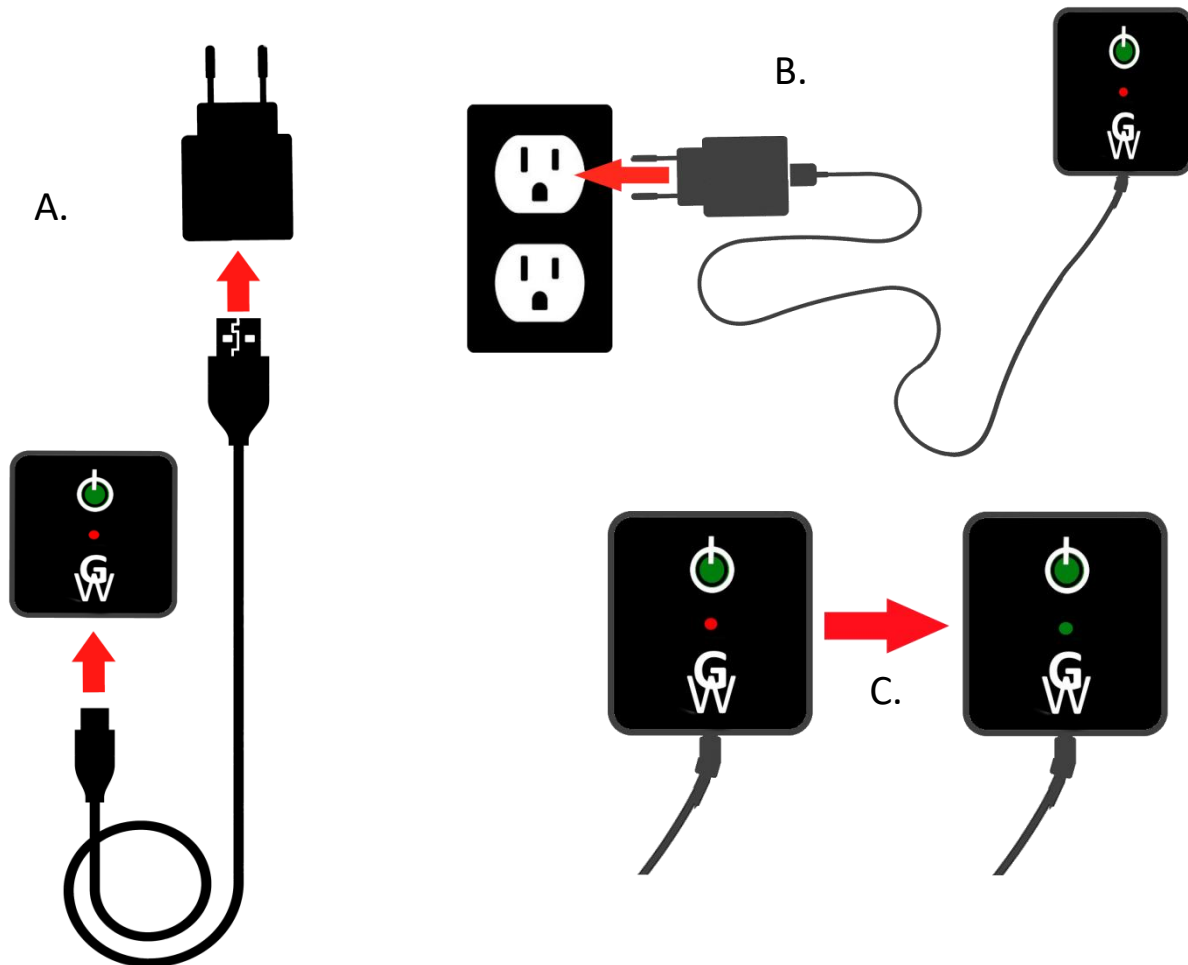

Step 2- Insert the light panel

Gently place the GroWell Light Panel Insert into the cap, smooth side down with the diodes facing the scalp as illustrated below. Tuck the edges of the panel into the cap's inner band.

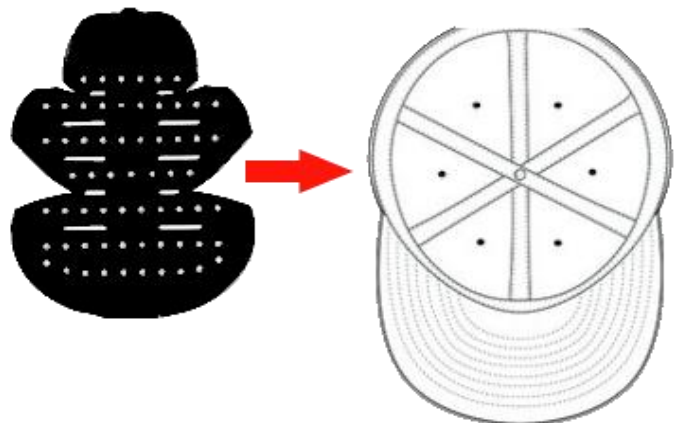

Step 3- Adjust Cap Size

The GroWell Cap is made to fit nearly every sized head. To adjust the size, lift the clasp on the sliding cap resizer, adjust its position until the cap fits you comfortably and close the clasp.



Step 4- Connect the Battery

Disconnect the charged Battery from the Charging Cable and connect it to the GroWell Light Panel using the GroWell Control Cable (USB-C to USB-C).



Step 5- Begin Treatment

Place the GroWell cap comfortably on your head and press the green button on the battery until it beeps three times. The light panel will illuminate and the indicator light will turn green signaling that your 25 minute GroWell session has begun. For your safety and convenience, if you remove the GroWell cap while in use the battery back will emit one beep, the lights will turn off and the indicator LED flash green/yellow to show the session is paused. To resume treatment, simply replace the cap on your head. You will hear one long beep and the paused session will proceed automatically for the duration of the time remaining.



A fully charged Battery should power 3-4 sessions. When running low, its indicator light will flash white to let you know it should be recharged.

**NOTE* Following a completed GroWell session, the light panel will shut off and the Battery light turn white indicating "Standby" mode. The Battery will automatically shut off after 10 minutes or, to shut down manually, press the Power button until you hear three beeps and the white indicator light turns off.*

Step 6- Store for Next Use

After 25 minutes, your GroWell will beep twice and the lights turn off to inform you that the GroWell session is complete.

Remove the cap, disconnect the GroWell Control Cable from the Battery and store everything in a convenient, dry place until the next use.

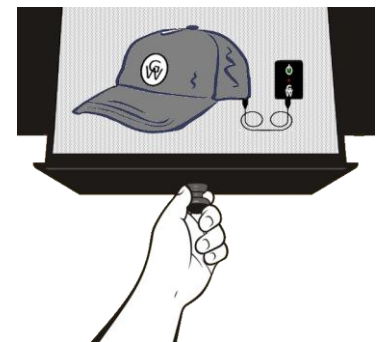

Monitoring Device Activity:

The GroWell is inspected and tested during production. Once the GroWell is connected to a charged battery, placed on the head and a session has begun the Lasers and LED's will illuminate and the timer will count down for 25 minutes. If you remove the GroWell during your treatment time, the session will pause and the lights turn off until the cap is replaced on the head. Do NOT

look directly at the lights while they are illuminated. If the Lasers or LEDs do not illuminate or you notice any other malfunction of the GroWell, please contact Apira Science, Inc. for instructions on how to proceed.

BATTERY PACK LED COLOR GUIDE

LED Color	Activity	Meaning
Red	Constant	Battery Charging
Green	Constant	Battery charged/Session underway
	Flashing	1 Minute left in session
White	Constant	Standby/Session complete
	Flashing	Battery low
Yellow	Constant	Treatment terminated due to high temperature
Green/Yellow	Flashing	Pause Mode

Cleaning Instructions:



UNPLUG THE GROWELL FROM THE BATTERY BEFORE CLEANING.

The GroWell does not require cleaning after each use, but thorough cleaning is recommended should it become soiled and for proper care and maintenance.

Before cleaning, always disconnect the Control Cable and Battery from the Light Panel Insert and carefully remove the Light Panel Insert from the cap. Using a soft, dry cloth, gently wipe both sides of the GroWell Light Panel Insert and inspect the results. If you find more cleaning is needed, repeat this step or slightly moisten the cloth with warm water and gently wipe until visually clean. Extra care must be taken when cleaning around the light sources.

DO NOT submerge in or expose any GroWell components to water.

DO NOT wipe using an abrasive cloth or sponges or with excessive pressure or force which may cause damage.

DO NOT use acetone, soap, detergents or solvents on any part of the GroWell. Doing so will damage the components and void the warranty.

Maintenance Instructions:

The GroWell is designed to provide years of trouble-free operation. If it is necessary to clean the unit surfaces, please follow the cleaning instructions in this manual.

Note: The GroWell has no parts that can be serviced by the user. If service is required, see the User Assistance section below for contact information for Apira Science, Inc.

Caution - Use of controls or adjustments or performance of procedures other than those specified in these instructions may void your manufacturer warranty or result in direct radiation exposure.

Operating and Storage/Transportation Instructions:

The GroWell should be operated in a dry environment (15%-85% humidity), with a temperature range of 15°C (59°F) to 30°C (86°F) atmospheric pressure range of 700hpa-986hpa; and stored or transported in a dry environment with a temperature range of 5°C (41°F) to 40°C (104°F),

atmospheric pressure range of 700hpa-986hpa. Do not store or transport the GroWell in a place with a maximum humidity higher than 85%. Do not store in direct sunlight, on hot surfaces such as radiators or heaters or near strong chemicals such as acids or bases.

Expected Life of the GroWell:

The GroWell is manufactured under strict quality controls and validated through GMP (Good Manufacturing Practices) and ISO 13485, an international quality standard for medical devices. The GroWell contains proprietary, high quality laser diodes and LEDs designed to last at least 10,000 hours. Based on that rating and the durability of the components being used, the expected life of the GroWell is 5 years of regular use. The GroWell is a non-serviceable device. Please read this entire instruction manual before operating the GroWell.

Disposal Instructions:

Some components of the GroWell are recyclable and some electronic components may not be legally disposed of in the area where you live. Most government agencies have procedures and locations for the disposal of electronics.



This symbol means that, according to local laws and regulations, the GroWell should be disposed of separately from household waste. At the end of its life, take the GroWell to a collection point designated by your local authorities.

Troubleshooting:

Before sending your GroWell in for repair, please try these helpful items. If these don't resolve your problem, please contact Apira Science's warranty department.

My GroWell is turning off during use

- Make sure your environment is not too warm. The GroWell is designed to control its maximum temperature by turning off the laser diodes when the sensor detects a temperature exceeding 39°C (102°F) and all diodes at temperatures above 40°C (104°F). Should this happen, the Battery indicator light will turn yellow. Press the power button until it turns off and put the GroWell in a cool, dry place until its temperature has reached an acceptable level then restart your session.
- Unplug and gently re-plug all connectors to make sure they are properly seated.
- Make sure the Battery holds sufficient charge for the entire session and recharge if needed.
- The GroWell is equipped with a sensor that will "pause" the session and turn the lights off if the cap is removed during use. If this is the issue, simply replace the cap on your head and your session will resume.

My GroWell will not turn on

- Recharge the Battery. A fully-charged GroWell Battery holds sufficient power for 3-4 sessions.
- Check the connections by unplugging and gently re-attaching the GroWell Control Cable from the Battery and the GroWell Light Panel.

NOTE: In the event of a malfunction of the GroWell's sensor, do not look directly into the light sources while they are illuminated. Disconnect the GroWell from the Battery and contact Customer Support.

My GroWell will not turn off

- Press and hold the POWER button for 5 seconds.
- Disconnect and reattach the GroWell Control Cable from the Battery.

If these tips did not resolve your problem, please contact Apira Science, Inc for assistance:

Apira Science, Inc.
409 Edmon Rd NE, Suite C
Albuquerque, NM 87107 USA
Tel. +1 (949) 854-9900
Toll-free in U.S.: +1 (800) 424-7937
Email: support@apirascience.com

NOTICE: Do not attempt to repair any portion of the GroWell. This appliance has no user-serviceable parts. If any malfunction occurs, disconnect the GroWell from any electrical source and contact Apira Science, Inc.

Warranty:

Failure to use and maintain the GroWell in accordance with the instructions in this manual will void the product warranty.

➤ **Two Year Limited Warranty**

Apira Science Inc. products are warranted to be free from defects in materials or workmanship for two years (24 months) from the date of purchase. Within this period, Apira Science Inc. will, at its discretion, repair or replace any components that fail in normal use. Such repairs or replacement will be made at no charge to the customer for parts or labor. This warranty does not apply to: (i) cosmetic damage, such as scratches, nicks and dents (ii) damage caused by accident, abuse, misuse, water, flood, fire, other acts of nature or external causes; (iii) damage caused by service performed by anyone who is not an authorized service provider of Apira Science; or (iv) damage to a product that has been modified or altered. Repairs have a 90-day warranty. If the unit sent in is still under its original warranty, the new warranty is 90 days or to the end of the original one-year warranty, whichever is longer.

THE WARRANTIES AND REMEDIES CONTAINED HEREIN ARE EXCLUSIVE AND IN LIEU OF ALL OTHER WARRANTIES EXPRESS, IMPLIED OR STATUTORY, INCLUDING ANY LIABILITY ARISING UNDER ANY WARRANTY OF MERCHANTABILITY OR FITNESS FOR A PARTICULAR PURPOSE, STATUTORY OR OTHERWISE. IN NO EVENT SHALL APIRA SCIENCE, INC. BE LIABLE FOR ANY INCIDENTAL, SPECIAL, INDIRECT, OR CONSEQUENTIAL DAMAGES, WHETHER RESULTING FROM THE USE, MISUSE, OR INABILITY TO USE THIS PRODUCT OR FROM DEFECTS IN THE PRODUCT.

Apira Science Inc. retains the exclusive right to repair or replace the device or software with a new or newly-overhauled replacement product or offer a full refund of the purchase price. SUCH REMEDIES SHALL BE AT THE SOLE DISCRETION OF APIRA SCIENCE, INC., AND WILL BE THE CUSTOMER'S EXCLUSIVE REMEDY FOR ANY BREACH OF WARRANTY. This warranty supersedes all other versions including product manuals, websites or other published representations.

➤ **Warranty Service**

To Obtain Warranty Service Please Complete These Two Easy Steps:

- 1. Contact Apira Science Support to receive an RMA number and shipping address.**

Call or e-mail Apira Science Support to describe the problem and, if a return or exchange is required, request a return material authorization (RMA) number. You will need to provide the unit's serial number, your name, return shipping address and a daytime phone number.

Phone: +1 949-854-9900











Email: support@apirascience.com

2. Ship the unit, with the RMA number clearly written on the box, to Apira Science, Inc.







Once you have received the RMA number, ship the unit (insured) to the address you've been given and include the RMA number prominently on the outside of the package.

Safety Labels:

The GroWell and its packaging have the following informational and safety labels:

Label	Description	Location
	Laser Product + Serial Number	Light Panel (Insert)
	ETL Label	
	Manufactured for & Date of Manufacture	Power Controller (Battery Pack)
	Battery Safety Label	
	Serial Number	Control Cable
	Label for "USB C to USB C Growell BT Control Cable"	
	Label for "USB A to USB C Growell BT Charging Cable "	Charging Cable
	Serial Number & Part Number	Retail Box
	UDI Code label (GS1 + Manufacturing Number)	
	Color Sticker (Hat Color)	

Symbol Explanation

Symbol	Explanation	Symbol	Explanation
	Date of manufacture		Manufacturer
	Type BF applied part		3R Laser Safety Symbol
IP22	Waterproof, dust proof level		General safety sign
	Follow instructions for use		Dispose of the device in accordance with the directive WEEE (Waste Electrical and Electronic Equipment)

Technical Specifications



- Total Output Power.** . . . 315mW
- Treatment Delivery.**3-4 Joules/cm2
- Light Delivery.** Direct from source
- Electrical Supply.** 3.8 V, 1A, 1800mAh
Lithium battery, charging voltage is 5V.
- Power Adapter.** Model: UES06WNCPU-050100SPA;
input:110 -240V, 50/60Hz, 0.2A; output:
DC5.0V---1.0A, 5.0W
- Warranty.** Two-year general warranty

Light Sources

LASERS

- Laser Diodes (Proprietary)..... 24
- Laser Classification (IEC 60825-1) ... Class 3R
- Wavelength..... 655nm
- Output..... 5mW

LEDS

- LED's (Proprietary)39
- LED Type- Superluminescent .. Focused
- Wavelength (Eq) 655nm
- Output 5mW

EMC Statement

- GroWell is used in home healthcare environment.
- GroWell conforms to the relevant requirements in IEC 60601-1-2.
- GroWell needs special precautions regarding EMC and needs to be installed and put into service according to the EMC information provided in the accompanying document.
- Portable and mobile RF communications equipment can affect the performance of GroWell. Strong electromagnetic interference shall be avoided during use, such as close to mobile phones, microwave ovens, etc.
- Portable RF communications equipment (including peripherals such as antenna cables and external antennas) should be used no closer than 30cm (12 inches) to any part of the GroWell, including cable specified by the manufacturer. Otherwise, degradation of the performance of this equipment could result.
- Device functions/performance: Laser and LED light output. When the functions/performance are lost or degraded due to EM disturbances, the light may be output abnormally. At this time, please turn off the device and use it in a place without EM disturbances.
- Guidance and manufacturer's statement can be seen in the attachment.

 **Warning:**

- Use of GroWell adjacent to or stacked with other equipment should be avoided as it could result in improper operation. If such use is necessary, all equipment should be observed to verify that they are operating normally.
- Use of cables other than those specified or provided by the manufacturer of GroWell could result in increased electromagnetic emissions or decreased electromagnetic immunity of this equipment and result in improper operation.

Cable information:

No.	NAME	Cable length (m)	Shielded or not	Remark
1	Charging cable	1.5	No	/

FCC Statement:

This device complies with part 15 of the FCC Rules. Operation is subject to the following two conditions:

- 1) This device may not cause harmful interference, and
- 2) This device must accept any interference received, including interference that may cause undesired operation.

Any changes or modifications not expressly approved by the party responsible for compliance could void the user's authority to operate the equipment. This equipment has been tested and found to comply with the limits for a Class B digital device, pursuant to part 15 of the FCC Rules. These limits are designed to provide reasonable protection against harmful interference in a residential installation. This equipment generates, uses and can radiate radio frequency energy and, if not installed and used in accordance with the instructions, may cause harmful interference to radio communications. However, there is no guarantee that interference will not occur in a particular installation. If this equipment does cause harmful interference to radio or television reception, which can be determined by turning the equipment off and on, the user is encouraged to try to correct the interference by one or more of the following measures:

- Reorient or relocate the receiving antenna.

- Increase the separation between the equipment and receiver.
- Connect the equipment into an outlet on a circuit different from that to which the receiver is connected.
- Consult the dealer or an experienced radio/TV technician for help.

FCC Radiation Exposure Statement:

This equipment complies with FCC radiation exposure limits set forth for an uncontrolled environment. This equipment should be installed and operated with a minimum distance of 20cm between the radiator & your body.

User Assistance:

If your GroWell is not working properly or a malfunction occurs, do not attempt to repair it. Disconnect from any electrical source and contact Apira Science, Inc. Customer Service at **1-949-854-9900, toll-free at 1-866-982-7472 (US Only)** or email support@apirascience.com for assistance.



Appendix A: EMC information

Table 1

Guidance and manufacturer’s declaration - electromagnetic emissions	
Emissions test	Compliance
RF emissions CISPR 11	Group 1
RF emissions CISPR 11	Class [B]
Harmonic emissions IEC 61000-3-2	Class A
Voltage fluctuations/ flicker emissions IEC 61000-3-3	Complies

Table 2

Guidance and manufacturer’s declaration - electromagnetic Immunity		
Immunity Test	IEC 60601-1-2 Test level	Compliance level
Electrostatic discharge (ESD)	±8kV contact ±2kV, ±4kV, ±8kV, ±15kV air	±8kV contact ±2kV, ±4kV, ±8kV, ±15kV air

IEC 61000-4-2		
Electrical fast transient/burst IEC 61000-4-4	±2kV for a.c. power lines	±2kV for a.c. power lines
Surge IEC 61000-4-5	±0.5kV and ±1kV for a.c. power line(s) to line(s)	±0.5kV and ±1kV for a.c. power line(s) to line(s)
Voltage dips, short interruptions and voltage variations on power supply input lines IEC 61000-4-11	0% UT; 0, 5 cycle g) At 0°, 45°, 90°, 135°, 180°, 225°, 270°and 315° 0% UT; 1 cycle and 70% UT; 25/30 cycles Single phase: at 0° 0% UT; 250/300 cycle	0% UT; 0, 5 cycle g) At 0°, 45°, 90°, 135°, 180°, 225°, 270°and 315° 0% UT; 1 cycle and 70% UT; 25/30 cycles Single phase: at 0° 0% UT; 250/300 cycle
Power frequency magnetic field IEC 61000-4-8	30 A/m	30 A/m
Conducted RF IEC61000-4-6	3 Vrms 0,15 MHz – 80 MHz 6 Vrms in the ISM and amateur radio bands	3 Vrms 0,15 MHz – 80 MHz 6 Vrms in the ISM and amateur radio bands
Radiated RF IEC61000-4-3	10 V/m 80 MHz – 2,7 GHz	10 V/m 80 MHz – 2,7 GHz
NOTE U _T is the a.c. mains voltage prior to application of the test level.		

Table 3

Guidance and manufacturer's declaration - electromagnetic Immunity							
Radiated RF IEC61000-4-3 (Test specifications for ENCLOSURE PORT	Test Frequency (MHz)	Band (MHz)	Service	Modulation	Modulation (W)	Distance (m)	IMMUNITY TEST LEVEL (V/m)
	385	380 –390	TETRA 400	Pulse modulation 18 Hz	1,8	0.3	27

IMMUNITY to RF wireless communicatio ns equipment)	450	430 –470	GMRS 460, FRS 460	FM ± 5 kHz deviation 1 kHz sine	2	0.3	28
	710	704 – 787	LTE Band 13, 17	Pulse modulatio n 217 Hz	0,2	0.3	9
	745						
	780						
	810	800 – 960	GSM 800/900, TETRA 800, iDEN 820, CDMA 850, LTE Band 5	Pulse modulatio n 18 Hz	2	0.3	28
	870						
	930						
	1720	1 700 – 1 990	GSM 1800; CDMA 1900; GSM 1900; DECT; LTE Band 1, 3, 4, 25; UMTS	Pulse modulatio n 217 Hz	2	0.3	28
	1845						
	1970						
	2450	2 400 – 2 570	Bluetooth, WLAN, 802.11 b/g/n, RFID 2450, LTE Band 7	Pulse modulatio n 217 Hz	2	0.3	28
	5240	5 100 – 5 800	WLAN 802.11 a/n	Pulse modulatio n 217 Hz	0,2	0.3	9
	5500						
5785							